

MB/1520-100

Revision 1.0

Hardware Reference

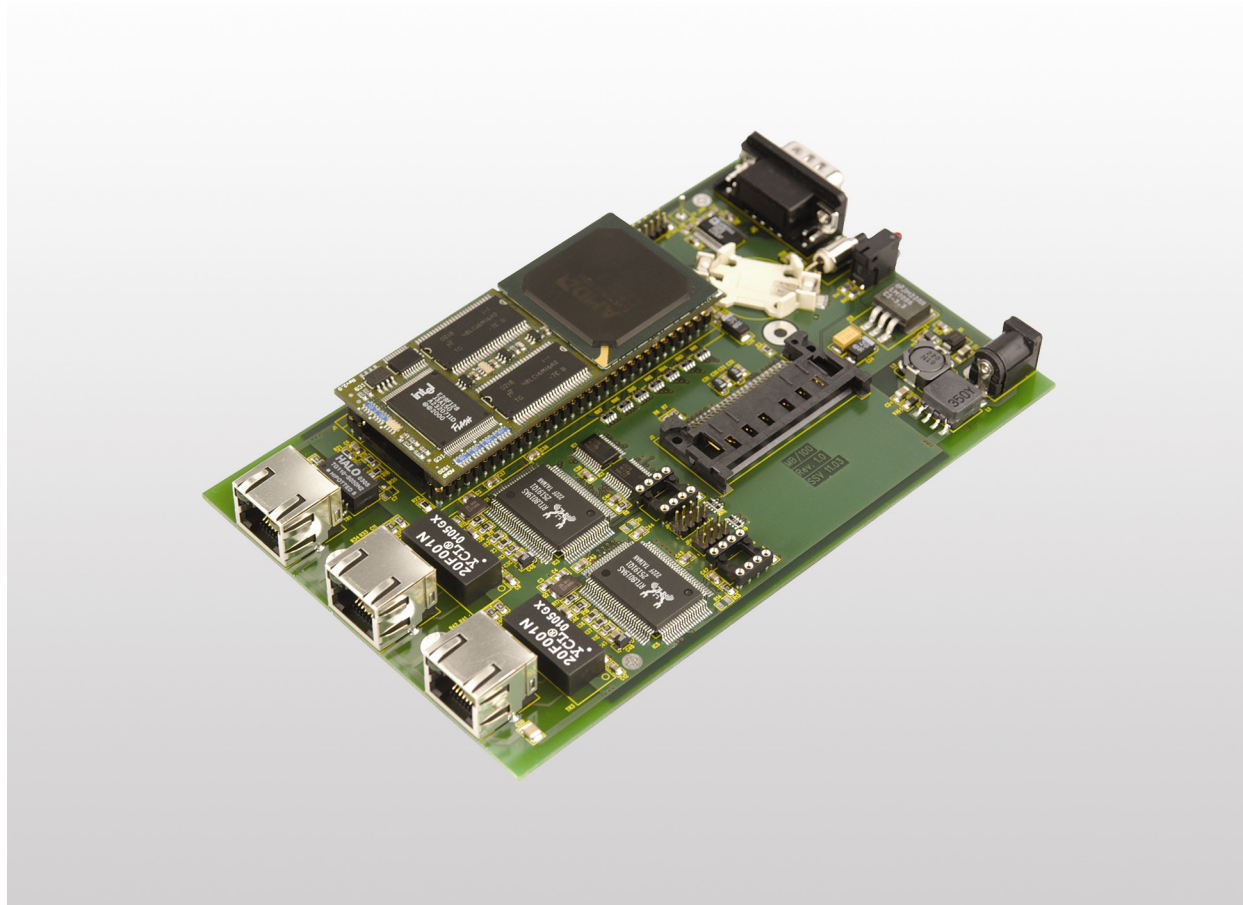

SSV Embedded Systems

Heisterbergallee 72

D-30453 Hannover

Tel. +49-(0)511-40000-0

Fax. +49-(0)511-40000-40

e-mail: sales@ist1.de

Manual Revision: 1.2

Date: 2004-04-26

CONTENT

1	INTRODUCTION	4
1.1	Conventions used in this Document	4
1.2	Checklist.....	4
1.3	Features MB/1520-100	5
1.4	Features DIL/NetPC ADNP/1520	5
2	BOARD LAYOUT.....	6
3	BOARD COMPONENTS	7
3.1	128-pin QIL socket	7
3.2	Interrupt LAN 2	7
3.3	RCM Jumper.....	7
3.4	COM1 Serial Interface	7
3.5	Reset Button	8
3.6	Power LED	8
3.7	Power Connector.....	8
3.8	Battery Holder	8
3.9	CompactFlash Slot	8
3.10	Base Address LAN 2	8
3.11	Base Address LAN 3	9
3.12	10/100Mbps Ethernet (LAN 1)	9
3.13	10Mbps Ethernet (LAN 2 and LAN 3).....	9
4	THE MB/100 CARRIER BOARD IN USE	10
4.1	Mounting the DIL/NetPC ADNP/1520.....	10
4.2	Providing with Power.....	10
4.3	COM1 Serial Link.....	11
4.4	Ethernet Link	12
4.5	Setting the LAN 1 Base Address	13
4.6	Setting the LAN 2 and LAN 3 Base Address.....	13
	APPENDIX 1: PIN ASSIGNMENT – 128-PIN QIL CONNECTOR	14
A1.1	Pin Assignment – 128-pin QIL Connector (1. Part)	14
A1.2	Pin Assignment – 128-pin QIL Connector (2. Part)	15
A1.3	Pin Assignment – 128-pin QIL Connector (3. Part)	16
A1.4	Pin Assignment – 128-pin QIL Connector (4. Part)	17
	APPENDIX 2: PIN ASSIGNMENT OF COMPONENTS.....	18
A2.1	COM1 Connector.....	18
A2.2	10/100 Mbps Ethernet Connector	18
A2.3	Power Connector	18
A2.4	CompactFlash Slot (1. Part)	19
A2.5	CompactFlash Slot (2. Part).....	20

LIST OF FIGURES 21

LIST OF TABLES 21

LIST OF APPENDIXES 21

CONTACT 22

TRADEMARK ANNOTATIONS..... 22

DOCUMENT HISTORY 22

1 INTRODUCTION

The focus of the MB/1520-100 is on safe communication via Ethernet technology. The MB/1520-100 offers therefore three LAN-ports, which are ready to go. One 10/100Mbps LAN-port and two 10Mbps ports are available to integrate the MB/1520-100 into various industrial solutions. Of course the purpose of this board is not limited only to communicating via Ethernet. With the modular DIL/NetPC ADNP/1520 there are plenty of ideas to realize.

This document describes how to start with the MB/1520-100. For further information about the individual components of this product you may follow the links from our website at <http://www.dilnetpc.com>.

Our Website contains a lot of technical information, which will be updated in regular periods.

1.1 Conventions used in this Document

Convention	Usage
<i>italic</i>	Filenames, Internet addresses like e.g. <i>www.ssv-embedded.de</i>
bold italic	User inputs, command lines and pathnames
bold	Important terms

Table 1-1: Convention usage

1.2 Checklist

Compare the content of your MB/1520-100 package with the standard checklist below. If any item is missing or appears to be damaged, please contact SSV Embedded Systems.

Standard Items

- ✓ MB/100 Carrier Board
- ✓ DIL/NetPC ADNP/1520
- ✓ Null modem cable
- ✓ Power supply
- ✓ Power cable
- ✓ User manual
- ✓ Support CD-ROM

1.3 Features MB/1520-100

- 128-pin QIL socket for one DIL/NetPC (like the ADNP/1520)
- One 10/100Mbps Ethernet interface (LAN 1)
- Two 10Mbps Ethernet interfaces (LAN 2 and LAN 3)
- RS232 serial interface (COM1)
- Power LED
- Ethernet TX/RX-LEDs
- One reset switch
- 5V DC power input connector
- Size 160 x 100mm

1.4 Features DIL/NetPC ADNP/1520

- AMD™ SC520 CPU with 133MHz clock speed and FPU
- 16/32/64Mbytes SDRAM memory
- 4/16Mbytes Flash memory
- 10/100Mbps Ethernet interface
- Real time clock
- IDE support
- Two 16C550 UART serial ports
- 20-bit general purpose high-speed parallel I/O
- Seven interrupt inputs, four chip select outputs
- In-system programming features
- 128-pin QIL connector
- 3.3 Volt low power design, single 3.3 V DC supply
- Size 82 x 36mm

2 BOARD LAYOUT

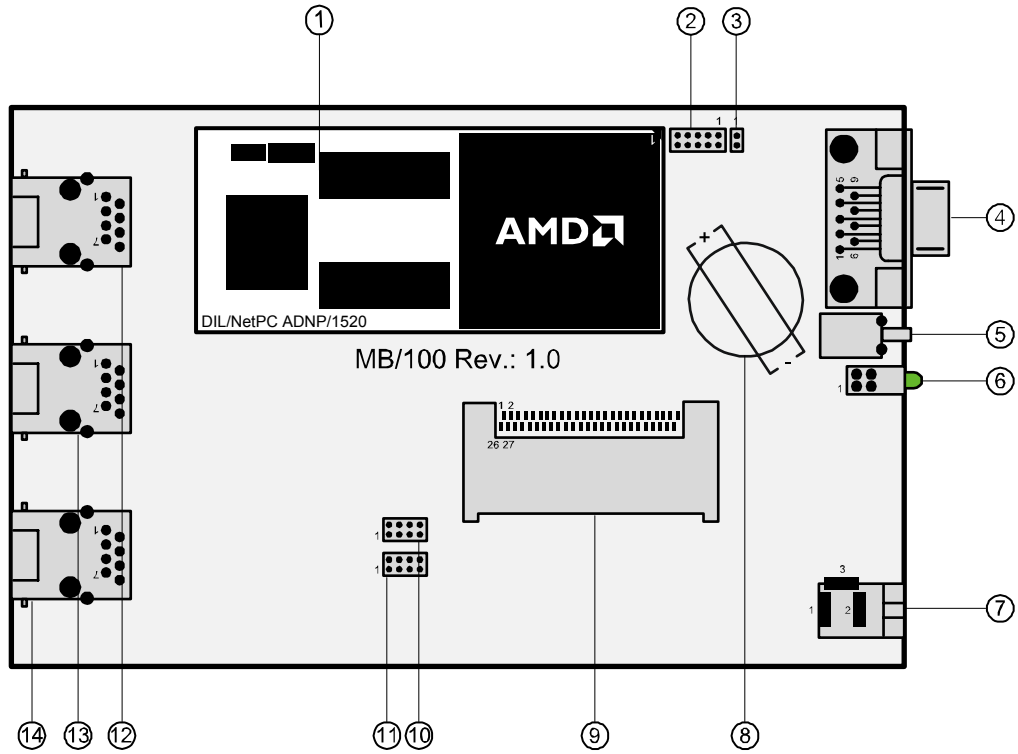

- | | |
|-------------------------|---------------------------|
| ① 128-pin QIL socket | ⑧ Battery holder |
| ② Interrupt LAN 2 (JP2) | ⑨ CompactFlash slot |
| ③ RCM jumper (JP1) | ⑩ Baseaddress LAN 2 (JP3) |
| ④ COM1 | ⑪ Baseaddress LAN 3 (JP4) |
| ⑤ Reset button | ⑫ LAN 1 |
| ⑥ Power LED | ⑬ LAN 2 |
| ⑦ Power connector | ⑭ LAN 3 |

Figure 2-1: Top view of MB/100 Carrier Board

3 BOARD COMPONENTS

This chapter describes the components of the MB/100 Carrier Board shown in **chapter 2** and gives a short overview about their respective functions.

3.1 128-pin QIL socket

The QIL socket with 128 pins can hold one DIL/NetPC ADNP/1520 or ADNP/1520 L. Please refer to **chapter 4.1** how to mount your DIL/NetPC safely. If you are interested in pin signals please refer to the appendix.

3.2 Interrupt LAN 2

With the JTAG interface JP2 it is possible to change the function of the PIO pins 1 to 20 of the ADNP/1520. The pins 1 to 20 are driven by an in-system programmable (ISP) high density PLD (ispMACH256 or similar). Please contact our support staff for more information.

3.3 RCM Jumper

Use the RCM-jumper JP1 to activate **RCM (Remote Console Mode)** for the ADNP/1520. RCM offers the possibility to control the ADNP/1520 via a terminal program.

To enable RCM place a jumper cap on both pins of the RCM-jumper, so that it is short. If you remove the jumper cap or place the jumper cap on just one pin, the jumper is not set and you can not use RCM.

RCM disabled (JP1 not set)



RCM enabled (JP1 set)



jumper cap

Figure 3-1: RCM-jumper in detail

If the RCM jumper is set you will see some boot messages on the serial port COM1. If the RCM jumper is not set, these messages are blocked.

3.4 COM1 Serial Interface

The MB/100 Carrier Board is equipped with a standard RS232 serial interface. This interface – named COM1 – comes with a 9-pin Sub-D male connector. The pin assignment of the COM1 interface is identical to the COM port assignment of a PC so it is possible to use a standard cable.

3.5 Reset Button

Press the reset button if the system hangs or you need to restart it. Pressing the reset button will only restart the ADNP/1520. To reset connected devices, turn off power from the system.

3.6 Power LED

The green power LED indicates a present supply voltage. This LED shines permanently when the MB/1520-100 is provided with 5V DC voltage by power supply. If this LED is off, check the connection between the power supply and the MB/1520-100.

3.7 Power Connector

The MB/1520-100 needs a supply voltage of 5V DC to work. In your MB/1520-100 package you will find a plug-in power supply unit to provide the system with the necessary power.

Caution:

Providing the MB/1520-100 with a voltage higher than the regular 5V DC $\pm 10\%$ could resolve in damaged board components!

3.8 Battery Holder

Place a 3V DC lithium battery type CR2032 in the battery holder to provide the clock with power when the power supply is removed.

3.9 CompactFlash Slot

With the CompactFlash slot you can connect CF cards to the MB/1520-100.

Note: The CompactFlash slot works only with CF cards in True-IDE-Mode. The CF cards must be hardwired as master.

Please see **chapter A2.4** and **A2.5** for the complete pinout of the CompactFlash slot.

There is a CF LED located directly above the Power LED. This red CF LED flashes when there is any activity on the CompactFlash slot.

3.10 Base Address LAN 2

The Jumper field JP3 allows you to change the base address for LAN 2. The default base address for LAN 2 is **340h**. Please refer to **chapter 4.6** for detailed information.

3.11 Base Address LAN 3

The Jumper field JP4 allows you to change the base address for LAN 3. The default base address for LAN 3 is **360h**. Please refer to **chapter 4.6** for detailed information.

3.12 10/100Mbps Ethernet (LAN 1)

The ADNP/1520 is using an SMSCTM LAN91C111 chip that allows Ethernet connectivity with a speed up to 100Mbps. The RJ45 Ethernet connector LAN 1 on the MB/1520-100 is connected to the SMSC LAN controller on the ADNP/1520.

The LAN 1 connector owns two LED. One green LED in the upper left and one yellow LED in the upper right corner.

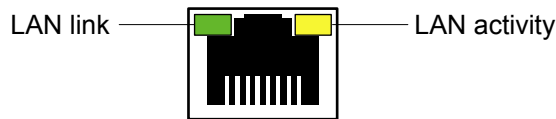

Figure 3-2: LEDs on LAN 1 connector

3.13 10Mbps Ethernet (LAN 2 and LAN 3)

Next to the LAN 1 port there are two 10Mbps Ethernet ports available – called LAN 2 and LAN 3. These ports have standard RJ45 interfaces. LAN 2 and LAN 3 are not provided through your ADNP/1520. Instead they come along with two Realtek LAN controller chips onboard. Both LAN-ports can be configured separately via jumper settings (please see **chapter 4.6**). This concerns the base addresses and interrupts.

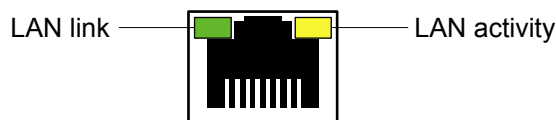

Figure 3-3: LEDs on LAN 2 and LAN 3 connector

Note: The LAN activity LEDs of LAN 2 and LAN 3 are inverted! The LEDs are on when there is no LAN activity and they are off when there is LAN activity.

4 THE MB/100 CARRIER BOARD IN USE

4.1 Mounting the DIL/NetPC ADNP/1520

To mount the ADNP/1520 on the MB/100 Carrier Board put it carefully on the 128-pin QIL socket. Please note, that the ADNP/1520 is positioned in the right way as shown in **figure 4-1**. After that, press the ADNP/1520 carefully down, so that the QIL socket fixes it.

Caution:

Too high pressure on the DIL/NetPC can resolve in damaged components and/or in bent or broken pins.

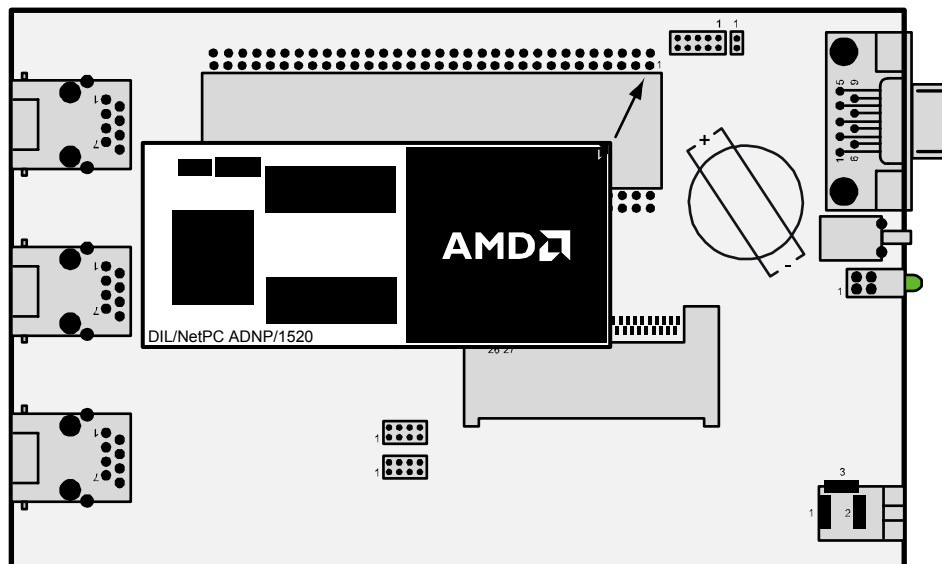

Figure 4-1: Mounting the ADNP/1520 DIL/NetPC

4.2 Providing with Power

The MB/1520-100 needs a supply voltage of 5V DC to work. In your carrier board package you will find a plug-in power supply unit to provide the system with the necessary power.

Caution:

Providing the MB/1520-100 with a voltage higher than the regular 5V DC $\pm 10\%$ could resolve in damaged board components.

SSV recommends to power off the MB/1520-100 every time you alter or modify board configurations like jumper settings or cable connections

4.3 COM1 Serial Link

COM1 is mostly used for basic communication with the MB/1520-100 and follows the RS232 protocol. The interface has a 9-pin Sub-D male connector. When using a remote terminal on this port, make sure the RCM jumper is set (please see **chapter 3.3**).

For a basic communication with the MB/1520-100 use a null modem cable on port COM1. This cable comes along with your MB/1520-100 package. Please connect the MB/1520-100 with the COM port of your development system by using this cable.

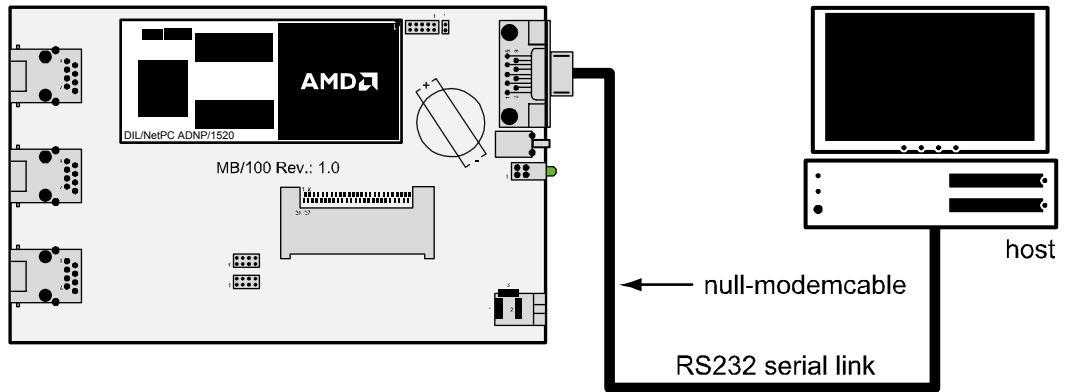

Figure 4-2: Serial link

4.4 Ethernet Link

The Ethernet link on port LAN 1 requires a patch cable that is 100Mbps compliant, i.e. a CAT5 cable. For Ethernet links on ports LAN 2 and 3 the patch cable must be 10Mbps compliant. Furthermore one hub or switch and an Ethernet LAN adapter for your development system are needed. The **figures 4-4 and 4-5** show the connections with port LAN 1. Connections to ports LAN 2 and LAN 3 can be made equivalently. Please refer to **chapter 4.6** for jumper settings for LAN 2 and LAN 3.

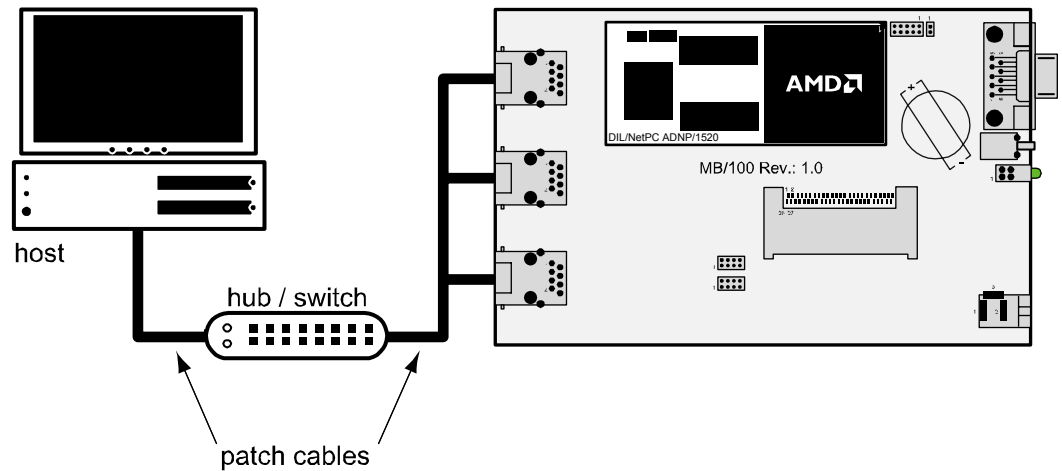

Figure 4-3: Ethernet link on LAN 1 with hub or switch

If you want to connect your development system directly to the MB/1520-100 place a crossover cable between these two systems as shown in **figure 4-5**.

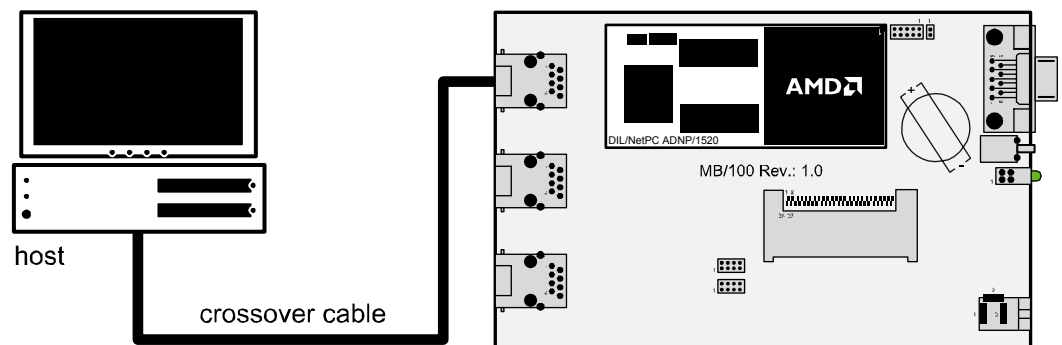

Figure 4-4: Ethernet link on LAN 1 with crossover cable

4.5 Setting the LAN 1 Base Address

The LAN 1 port base address is fixed on **300h**. This setting can not be changed.

4.6 Setting the LAN 2 and LAN 3 Base Address

By default the base address for LAN 2 is set to **340h**. The default base address of LAN 3 is set to **360h**. Please make sure that the base addresses of LAN 2 and LAN 3 are not set to an equal value – LAN 2 and LAN 3 must be set to different base addresses.

To change the LAN 2 or LAN 3 base address the jumpers JP3 and JP4 have to be set like shown in **table 4-1** above. The example below shows the jumper position to set the base address on 340h. Please refer to **table 4-1** to configure LAN 2 and LAN 3 on other base addresses.

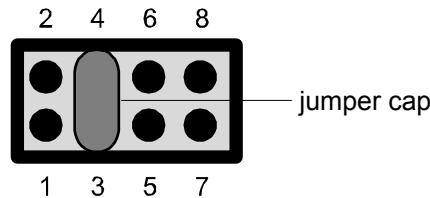

Figure 4-5: LAN base address jumper in detail

Default	Base Address	Pins 1 and 2	Pins 3 and 4
LAN 1 (fixed)	300h	open	open
	320h	close	open
LAN 2	340h	open	close
LAN 3	360h	close	close
	380h	open	open
	3A0h	close	open
	3C0h	open	close
	3E0h	close	close
	200h	open	open
	220h	close	open
	240h	open	close
	260h	close	close
	280h	open	open
	2A0h	close	open
	2C0h	open	close
	2E0h	close	close

Table 4-1: Jumper positions for base addresses LAN 2 and LAN 3

APPENDIX 1: PIN ASSIGNMENT – 128-PIN QIL CONNECTOR

A1.1 Pin Assignment – 128-pin QIL Connector (1. Part)

Pin	Name	Group	Function
1	PA0	PIO	Parallel I/O, port A, bit 0*
2	PA1	PIO	Parallel I/O, port A, bit 1*
3	PA2	PIO	Parallel I/O, port A, bit 2*
4	PA3	PIO	Parallel I/O, port A, bit 3*
5	PA4	PIO	Parallel I/O, port A, bit 4*
6	PA5	PIO	Parallel I/O, port A, bit 5*
7	PA6	PIO	Parallel I/O, port A, bit 6*
8	PA7	PIO	Parallel I/O, port A, bit 7*
9	PB0	PIO	Parallel I/O, port B, bit 0*
10	PB1	PIO	Parallel I/O, port B, bit 1*
11	PB2	PIO	Parallel I/O, port B, bit 2*
12	PB3	PIO	Parallel I/O, port B, bit 3*
13	PB4	PIO	Parallel I/O, port B, bit 4*
14	PB5	PIO	Parallel I/O, port B, bit 5*
15	PB6	PIO	Parallel I/O, port B, bit 6*
16	PB7	PIO	Parallel I/O, port B, bit 7*
17	PC0	PIO	Parallel I/O, port C, bit 0*
18	PC1	PIO	Parallel I/O, port C, bit 1*
19	PC2	PIO	Parallel I/O, port C, bit 2*
20	PC3	PIO	Parallel I/O, port C, bit 3*
21	RXD1	SIO	COM1 serial port, RXD pin
22	TXD1	SIO	COM1 serial port, TXD pin
23	CTS1	SIO	COM1 serial port, CTS pin
24	RTS1	SIO	COM1 serial port, RTS pin
25	DCD1	SIO	COM1 serial port, DCD pin
26	DSR1	SIO	COM1 serial port, DSR pin
27	DTR1	SIO	COM1 serial port, DTR pin
28	RI1	SIO	COM1 serial port, RI pin
29	RESIN	RESET	Reset input
30	TX+	LAN	Ethernet interface, TX+ pin
31	TX-	LAN	Ethernet interface, TX- pin
32	GND	----	Ground

Table A1-1: ADNP/1520 pinout – pin 1 to 32

The PIO pins 1 to 20 are driven by an in-system programmable (ISP) high density PLD (ispMACH256 or similar). It is possible to change the function of these pins over the ADNP/1520 JTAG interface. Please contact our support staff for more information.

A1.2 Pin Assignment – 128-pin QIL Connector (2. Part)

Pin	Name	Group	Function
33	RX+	LAN	Ethernet interface, RX+ pin
34	RX-	LAN	Ethernet interface, RX- pin
35	RESOUT	RESET	Reset output
36	VBAT	PSP	SC520 real time clock battery input
37	CLKOUT	PSP	Clock output (default 1.8432 MHz)
38	TXD2	PSP	COM2 serial port, TXD pin
39	RXD2	PSP	COM2 serial port, RXD pin
40	INT5	PSP	Programmable interrupt input 5
41	INT4	PSP	Programmable interrupt input 4
42	INT3	PSP	Programmable interrupt input 3
43	INT2	PSP	Programmable interrupt input 2
44	INT1	PSP	Programmable interrupt input 1
45	CS4	PSP	Programmable chip select output 4
46	CS3	PSP	Programmable chip select output
47	CS2	PSP	Programmable chip select output 2
48	CS1	PSP	Programmable chip select output 1
49	IOCHRDY	PSP	I/O channel ready
50	IOR	PSP	I/O read signal, I/O expansion bus
51	IOW	PSP	I/O write signal, I/O expansion bus
52	SA3	PSP	System expansion bus, address bit 3
53	SA2	PSP	System expansion bus, address bit 2
54	SA1	PSP	System expansion bus, address bit 1
55	SA0	PSP	System expansion bus, address bit 0
56	SD7	PSP	System expansion bus, data bit 7
57	SD6	PSP	System expansion bus, data bit 6
58	SD5	PSP	System expansion bus, data bit 5
59	SD4	PSP	System expansion bus, data bit 4
60	SD3	PSP	System expansion bus, data bit 3
61	SD2	PSP	System expansion bus, data bit 2
62	SD1	PSP	System expansion bus, data bit 1
63	SD0	PSP	System expansion bus, data bit 0
64	Vcc	PSP	3.3V power input

Table A1-2: ADNP/1520 pinout – pin 33 to 64

A1.3 Pin Assignment – 128-pin QIL Connector (3. Part)

Pin	Name	Group	Function
65	SBHE	PSP	System byte high enable, sys. exp. bus
66	IOCS16	PSP	I/O chip select 16, sys. expansion bus
67	MEMCS16	PSP	Memory chip select 16, sys. exp. bus
68	MEMW	PSP	Memory write signal, sys. expansion
69	MEMR	PSP	Memory read signal, sys. expansion bus
70	BALE	PSP	bus address latch enable, sys. exp. bus
71	AEN	PSP	Address enable signal, sys. expansion
72	Reserved	PSP	Reserved. don't use
73	RCME	PSP	Remote Console Mode enable
74	Reserved	PSP	Reserved. don't use
75	Reserved	PSP	Reserved. don't use
76	Reserved	PSP	Reserved. don't use
77	Reserved	PSP	Reserved. don't use
78	Reserved	PSP	Reserved. don't use
79	Reserved	PSP	Reserved. don't use
80	Reserved	PSP	Reserved. don't use
81	Reserved	PSP	Reserved. don't use
82	Reserved	PSP	Reserved. don't use
83	Reserved	PSP	Reserved. don't use
84	Reserved	PSP	Reserved. don't use
85	INT6	PSP	Programmable interrupt input 6
86	INT7	PSP	Programmable interrupt input 7
87	IDERES	PSP	IDE interface reset output
88	IDECS0	PSP	IDE interface chip select 0
89	IDECS1	PSP	IDE interface chip select 1
90	Reserved	PSP	Reserved. don't use
91	Reserved	PSP	Reserved. don't use
92	Reserved	PSP	Reserved. don't use
93	Reserved	PSP	Reserved. don't use
94	Reserved	PSP	Reserved. don't use
95	Reserved	PSP	Reserved. don't use
96	GND	---	Ground

Table A1-3: ADNP/1520 pinout – pin 65 to 96

A1.4 Pin Assignment – 128-pin QIL Connector (4. Part)

Pin	Name	Group	Function
97	LANLED	PSP	LAN interface activity LED
98	Reserved	PSP	Reserved. don't use
99	RSTDRV	PSP	Reset output, System expansion bus
100	SA23	PSP	System expansion bus, address bit 23
101	SA22	PSP	System expansion bus, address bit 22
102	SA21	PSP	System expansion bus, address bit 21
103	SA20	PSP	System expansion bus, address bit 20
104	SA19	PSP	System expansion bus, address bit 19
105	SA18	PSP	System expansion bus, address bit 18
106	SA17	PSP	System expansion bus, address bit 17
107	SA16	PSP	System expansion bus, address bit 16
108	SA15	PSP	System expansion bus, address bit 15
109	SA14	PSP	System expansion bus, address bit 14
110	SA13	PSP	System expansion bus, address bit 13
111	SA12	PSP	System expansion bus, address bit 12
112	SA11	PSP	System expansion bus, address bit 11
113	SA10	PSP	System expansion bus, address bit 10
114	SA9	PSP	System expansion bus, address bit 9
115	SA8	PSP	System expansion bus, address bit 8
116	SA7	PSP	System expansion bus, address bit 7
117	SA6	PSP	System expansion bus, address bit 6
118	SA5	PSP	System expansion bus, address bit 5
119	SA4	PSP	System expansion bus, address bit 4
120	SD15	PSP	System expansion bus, data bit 15
121	SD14	PSP	System expansion bus, data bit 14
122	SD13	PSP	System expansion bus, data bit 13
123	SD12	PSP	System expansion bus, data bit 12
124	SD11	PSP	System expansion bus, data bit 11
125	SD10	PSP	System expansion bus, data bit 10
126	SD9	PSP	System expansion bus, data bit 9
127	SD8	PSP	System expansion bus, data bit 8
128	Vcc	---	3.3V power input

Table A1-4: ADNP/1520 pinout - pin 97 to 128

APPENDIX 2: PIN ASSIGNMENT OF COMPONENTS

A2.1 COM1 Connector

Top view	Pin	Name	Function
	1	DCD	COM1 serial port, DCD pin
	2	RXD	COM1 serial port, RXD pin
	3	TXD	COM1 serial port, TXD pin
	4	DTR	COM1 serial port, DTR pin
	5	GND	Ground
	6	DSR	COM1 serial port, DSR pin
	7	RTS	COM1 serial port, RTS pin
	8	CTS	COM1 serial port, CTS pin
	9	RI	COM1 serial port, RI pin

Table A2-1: Pinout COM1 connector

Note: All COM1-port signals are on RS232 level. There is no TTL level available on these port.

A2.2 10/100 Mbps Ethernet Connector

Top view	Pin	Name	Function
	1	TX+	10/100 Mbps LAN, TX+ pin
	2	TX-	10/100 Mbps LAN, TX- pin
	3	RX+	10/100 Mbps LAN, RX+ pin
	4	---	Not connected
	5	---	Not connected
	6	RX-	10/100 Mbps LAN, RX- pin
	7	---	Not connected
	8	---	Not connected

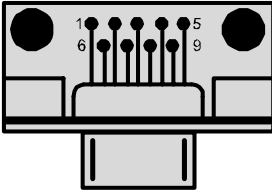
Table A2-2: Pinout 10/100 Mbps Ethernet connector

A2.3 Power Connector

Top view	Pin	Name	Function
	1	Vcc	Power In
	2	GND	Ground
	3	GND	Ground

Table A2-3: Pinout power connector

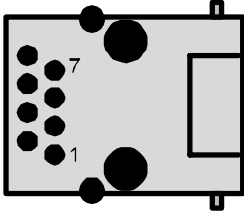
A2.4 CompactFlash Slot (1. Part)

Top view	Pin	Name	Function
	1	GND	Ground
	2	D3	D3
	3	D4	D4
	4	D5	D5
	5	D6	D6
	6	D7	D7
	7	CS0#	IDE_CS0#
	8	A10	Ground
	9	ATASEL#	Ground
	10	A9	Ground
	11	A8	Ground
	12	A7	Ground
	13	Vcc	Power
	14	A6	Ground
	15	A5	Ground
	16	A4	Ground
	17	A3	Ground
	18	A2	S_A2
	19	A1	S_A1
	20	A0	S_A0
	21	D0	S_D0
	22	D1	S_D1
	23	D2	S_D2
	24	IOCS16#	Misc 25
	25	CD2#	CF CD2#

Table A2-4: Pinout CompactFlash slot – pin 1 to 25

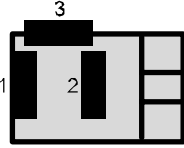
Note: The CompactFlash slot works only with CF cards in True-IDE-Mode. The CF cards must be hardwired as master.

A2.5 CompactFlash Slot (2. Part)

Top view	Pin	Name	Function
	26	CD1#	CF_CD1#
	27	D11	S_D11
	28	D12	S_D12
	29	D13	S_D13
	30	D14	S_D14
	31	D15	S_D15
	32	CS1#	IDE_CS1#
	33	VS1	---
	34	IOR#	Misc 4
	35	IOW#	Misc 3
	36	WE#	Vcc
	37	IRQ	IDE_IRQ
	38	Vcc	Power
	39	CSEL#	Ground
	40	VS2	---
	41	RESET#	IDE_RST#
	42	IOCHRDY	Misc 10
	43	INPACK#	---
	44	REG#	Vcc 3
	45	DASP#	IDE_DASP#
	46	PDIAG#	---
	47	D8	S_D8
	48	D9	S_D9
	49	D10	S_D10
	50	GND	Ground

Table A2-5: Pinout CompactFlash slot – pin 26 to 50

Note: The CompactFlash slot works only with CF cards in True-IDE-Mode. The CF cards must be hardwired as master.

LIST OF FIGURES

Figure 2-1: Top view of MB/100 Carrier Board.....	6
Figure 3-1: RCM-jumper in detail.....	7
Figure 3-2: LEDs on LAN 1 connector	9
Figure 3-3: LEDs on LAN 2 and LAN 3 connector.....	9
Figure 4-1: Mounting the ADNP/1520 DIL/NetPC	10
Figure 4-2: Serial link	11
Figure 4-3: Ethernet link on LAN 1 with hub or switch	12
Figure 4-4: Ethernet link on LAN 1 with crossover cable	12
Figure 4-5: LAN base address jumper in detail.....	13

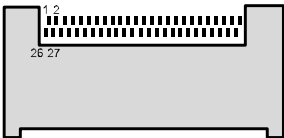
LIST OF TABLES

Table 1-1: Convention usage	4
Table 4-1: Jumper positions for base addresses LAN 2 and LAN 3	13
Table A1-1: ADNP/1520 pinout – pin 1 to 32	14
Table A1-2: ADNP/1520 pinout – pin 33 to 64	15
Table A1-3: ADNP/1520 pinout – pin 65 to 96	16
Table A1-4: ADNP/1520 pinout - pin 97 to 128	17
Table A2-1: Pinout COM1 connector.....	18
Table A2-2: Pinout 10/100 Mbps Ethernet connector.....	18
Table A2-3: Pinout power connector.....	18
Table A2-4: Pinout CompactFlash slot – pin 1 to 25.....	19
Table A2-5: Pinout CompactFlash slot – pin 26 to 50.....	20

LIST OF APPENDIXES

A1.1 Pin Assignment – 128-pin QIL Connector (1. Part).....	14
A1.2 Pin Assignment – 128-pin QIL Connector (2. Part).....	15
A1.3 Pin Assignment – 128-pin QIL Connector (3. Part).....	16
A1.4 Pin Assignment – 128-pin QIL Connector (4. Part).....	17
A2.1 COM1 Connector.....	18
A2.2 10/100 Mbps Ethernet Connector	18
A2.3 Power Connector	18
A2.4 CompactFlash Slot (1. Part)	19
A2.5 CompactFlash Slot (2. Part)	20

CONTACT

SSV Embedded Systems

Heisterbergallee 72

D-30453 Hannover

Tel. +49-(0)511-40000-0

Fax. +49-(0)511-40000-40

e-mail: sales@ist1.de

Internet: www.ssv-comm.de

TRADEMARK ANNOTATIONS

AMD, the AMD logo and combinations thereof are trademarks of Advanced Micro Devices, Inc.

Standard Microsystems and SMSC are registered trademarks of Standard Microsystems Corporation.

Other word marks and logos are owned by their respective holders.

DOCUMENT HISTORY

Revision	Date	Remarks	Name
1.0	2004-02-18	first version	JNE
1.1	2004-04-07	layout modified	WBU
1.2	2004-04-26	error and layout correction	WBU

This document is written only for the internal application. The content of this document can change any time without announcement. There is taken over no guarantee for the accuracy of the statements.

Copyright © **SSV EMBEDDED SYSTEMS 2004**. All rights reserved.

INFORMATION PROVIDED IN THIS DOCUMENT IS PROVIDED 'AS IS' WITHOUT WARRANTY OF ANY KIND. The user assumes the entire risk as to the accuracy and the use of this document. Some names within this document can be trademarks of their respective holders.